

Fourier Transform Infrared Spectrophotometer

IRTracer-100



New Levels of Performance and Quality Created by Excellent Sensitivity, Speed and Resolution



Excellent Sensitivity, Speed and Resolution

- ▶ Quickly and easily obtain high-quality data for any kind of sample.
- ▶ Quickly analyze data with user-friendly LabSolutions™ IR software.
- ▶ High-speed generation of analysis reports.

Shimadzu's technologies provide the high performance needed for your IR Analysis.

CONTENTS

- ▶ 4 New Levels of Performance and Quality
Created by Excellent Sensitivity, Speed and Resolution
- ▶ 5 High Sensitivity, High Resolution and High Speed
- ▶ 6 Reliable High Performance
- ▶ 10 New Generation of Workstation
- ▶ 11 Fast, Easy-to-Use LabSolutions IR Series Software
- ▶ 12 Solutions Achieved with LabSolutions
- ▶ 14 Extensive Spectra Library and a High-Performance Search Function
- ▶ 15 Automation and Labor-savings with Macro Program Functions
- ▶ 16 Meeting the Needs of a Wide Range of Analyses
Customize Your Own IRTracer-100 System
- ▶ 18 Various Application Programs Support All Analyses
- ▶ 20 EDXIR-Analysis Software (Option)
- ▶ 21 Sample Holder/Stocker for Contaminant Measurement EDXIR-Holder (Option)
- ▶ 22 Hardware Options
- ▶ 26 Software Options
- ▶ 28 Specifications

IRTracer™ -100

Fourier Transform Infrared Spectrophotometer

Excellent Sensitivity and Reliability

High Sensitivity, Resolution, and Speed:
Techniques to stabilize and optimize the interferometer provide high sensitivity.

New Generation of Workstation

LabSolutions IR software has been optimized for network applications, includes an extensive library of spectra, and features a high-performance search function. In addition, Macro functions provide automation and labor savings.

Meeting the Needs of a Wide Range of Analyses

Two main application programs support all analyses.
A wide variety of options to meet every application is available.



This product is certified as Shimadzu's Eco-Products Plus.

*Energy savings: 34% reduction
as compared to the previous model

New Levels of Performance and Quality Created by Excellent Sensitivity, Speed and Resolution

Quickly and easily obtain high-quality data for any kind of sample.



High-Sensitivity Measurements, with an SN Ratio of 60,000:1*1

A trace amount of silicone oil in paraffin oil were measured using the IRTracer-100 with a single reflection ATR attachment.

The peak from the silicone was extremely weak ($1,260\text{ cm}^{-1}$), a mere 0.00015 absorbance, but it was measured with a high S/N ratio.

Remarks:

- Differential spectrum with the spectrum of the paraffin oil subtracted
- Measured with a DLATGS detector, at a resolution of 4 cm^{-1}

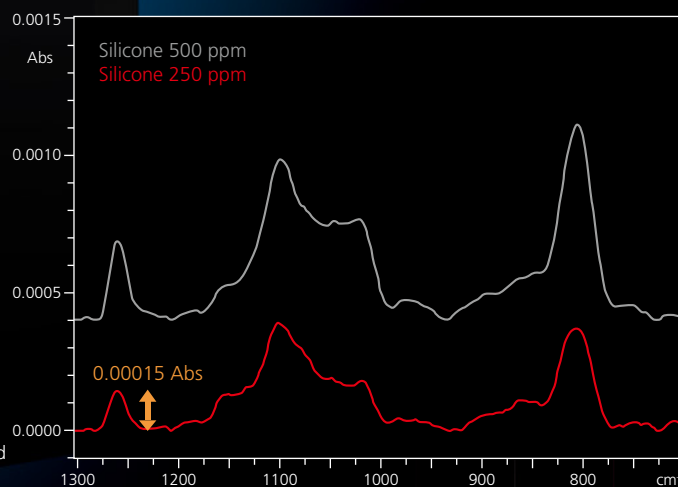

High Sensitivity, High Resolution and High Speed

The IRTracer-100 features the highest SN ratio in its class at 60,000:1, 0.25 cm^{-1} resolution, and high-speed scanning capable of 20 spectra/second.

Acquire High-Resolution Spectra with a 0.25 cm^{-1} Resolution Setting

Highly accurate quantitation and identification can be achieved with 0.25 cm^{-1} resolution.

For example, this resolution is suitable for the detailed analysis of each peak in a gas sample. When ammonia gas was run at 0.25 cm^{-1} resolution, peaks in the 785 – 790 cm^{-1} ranges were clearly resolved.

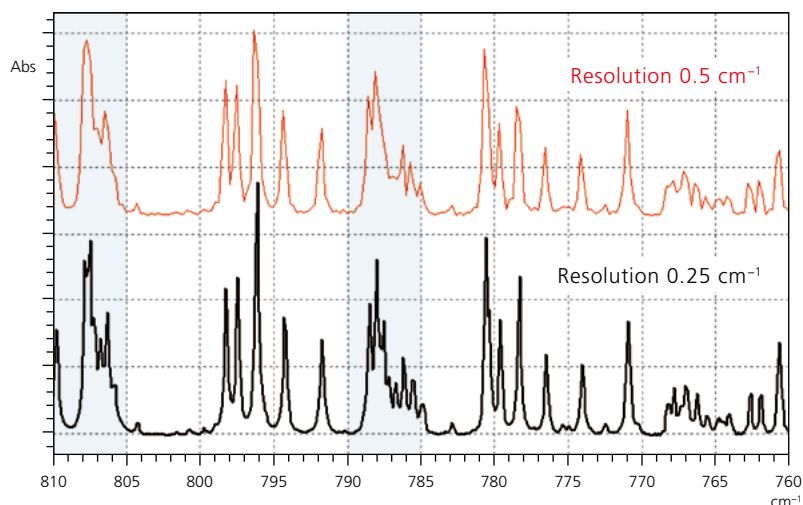

Achieve High-Speed Analysis with a 20 Hz Rapid Scan Feature*2

The rapid scan function allows a maximum of 20 spectra per second to be obtained. This makes the IRTracer-100 suitable for fast reactions that occur within a few seconds and for kinetic studies occurring in less than one second.

Rapid, high-sensitivity analysis with a 2,000:1 SN is available.

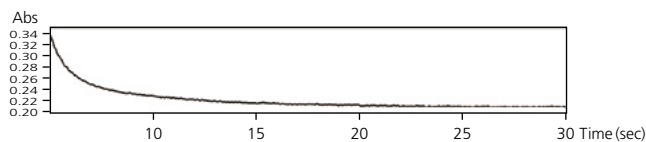
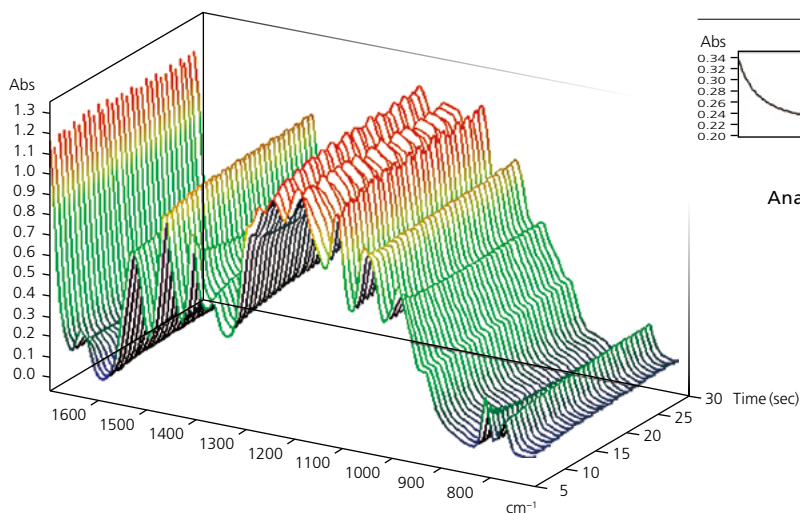
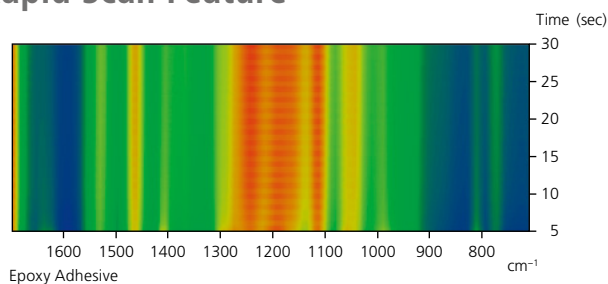

Analysis of curing reaction of UV light curable resin

Sample: UV light curing adhesive
Resolution: 16 cm^{-1}
Scan accumulation: 1 scan
Interval: 50 msec
Monitor: Peak at around 1,400 cm^{-1}
Detector: MCT

*1 peak-to-peak, 4 cm^{-1} resolution, in a neighborhood of 2,200 cm^{-1} , 1-minute accumulation *2 16 cm^{-1} resolution. Rapid scan program is optional.

Reliable High Performance

An automatic dehumidifier and advanced dynamic alignment enable easy maintenance of the interferometer.

Built-in Automatic Dehumidifier Allows for Easy Maintenance

Beam splitters used in FTIR interferometers are susceptible to humidity. In order to maintain the long-term stability of the interferometer, the beam splitter must be protected from moisture. To address this issue, the IRTracer-100 has been engineered with an airtight interferometer that incorporates a unique internal Automatic Dehumidifier.

Three Measures Taken to Protect the Optical Element in the Interferometer

The interferometer is sealed in an airtight housing.

An electronic Automatic Dehumidifier continuously removes any moisture, ensuring a dry interferometer chamber.

The beam splitter is covered with a moisture-resistant protective coat.

Principle of the Automatic Dehumidifier

The IRTracer-100 incorporates an Automatic Dehumidifier that electrolytically removes the moisture inside the interferometer using a solid polymer electrolytic membrane.

Because the electric power required to operate the Automatic Dehumidifier is less than the continuous operation of the FTIR, it can reduce CO₂ emissions by approximately 400 kg/year.*

- 1 When porous electrodes are attached to a solid polymer electrolytic membrane and direct current is applied, moisture on the anode side (i.e., the desiccation side) dissociates into hydrogen ions and oxygen.
- 2 The hydrogen ions travel through the solid polymer electrolytic membrane and reach the cathode side (i.e., the moisture discharge side).
- 3 At the cathode, the hydrogen ions react with oxygen in the air to form (gaseous) water vapor, which is released outside the interferometer.

Anode
(desiccation side)

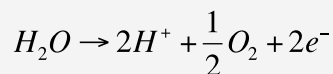

Cathode
(moisture discharge side)

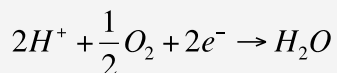

Replacing the window (KBr) at the sample compartment with an optional KRS-5 window (P/N 206-74211-58) ensures safe operation with no concern for the window plate becoming cloudy under a high humidity environment.

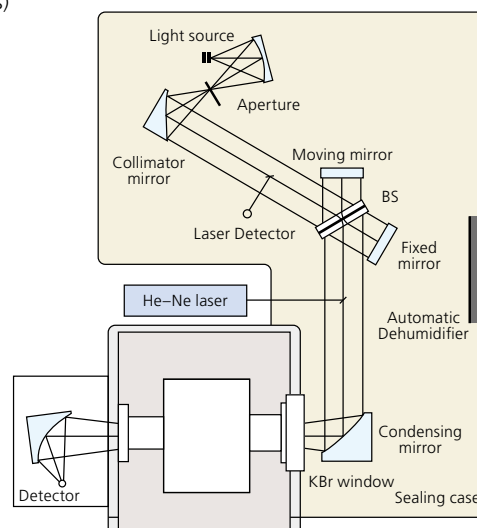
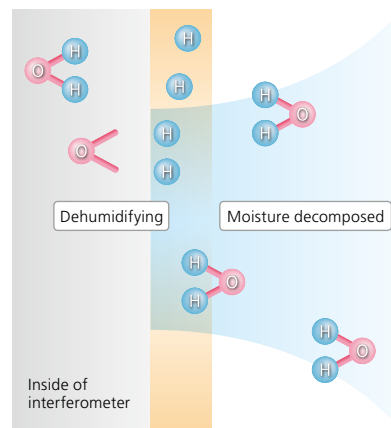

* Model case by SHIMADZU

The IRTracer-100's interferometer is optimized and stabilized using a combination of a smooth moving mirror system and the Advanced Dynamic Alignment. To assure that the IRTracer-100 is always in the optimum operating condition, a self diagnoses routine monitors the operation of the system at initialization and constantly during operation. In addition, standard EP/CHP/JP/USP/ASTM validation programs are provided to evaluate the FTIR performance.

Incorporation with Advanced Dynamic Alignment

Achieving reproducible optical interference in a spectrophotometer requires a robust interferometer design. The interferometer in the IRTracer-100 easily meets this requirement. The smooth moving mirror system monitored by the Advanced Dynamic Alignment (Japanese Patent No. 3613171) system allows the IRTracer-100 to provide optimum

and stable quality spectra after only a short warm-up time. Sampling at over 5000 times/second the Advanced Dynamic Alignment keeps the IRTracer-100 in optimum operating condition. In addition, the Advanced Dynamic Alignment system automatically aligns the interferometer when the beam splitter is changed for NIR or FIR analysis.

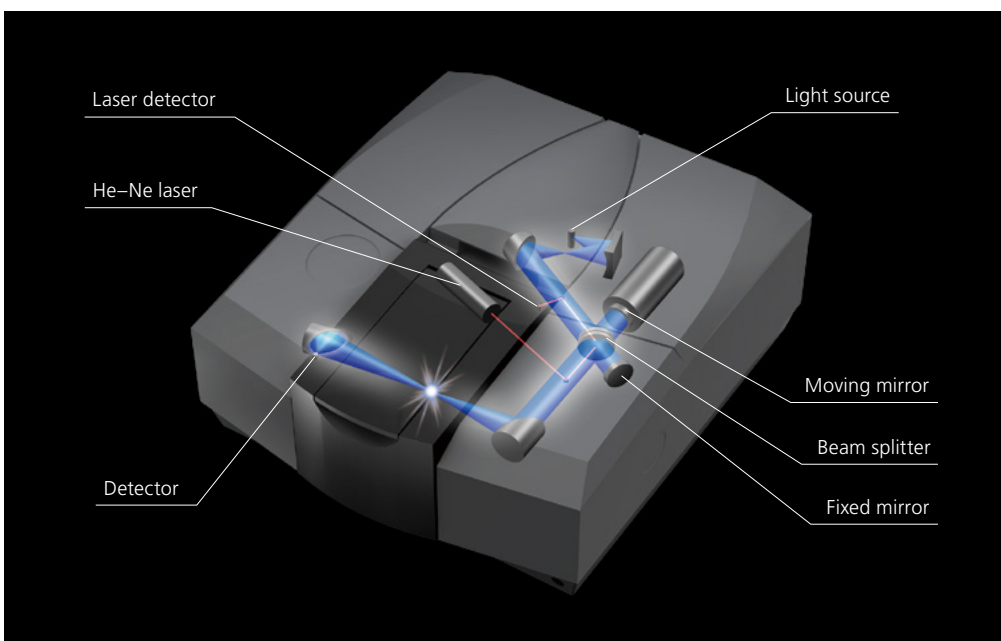

Four Benefits of Advanced Dynamic Alignment

Removes the influence of environmental variations

Allows the FTIR to be powered off when not in use* (saving electricity and reducing the environmental impact)

Shorter warm-up times and enhanced stability

Provides for a maintenance-free system

Scheme of Advanced Dynamic Alignment

- 1 The interference pattern of the He-Ne laser light is detected by the Laser Detector.
- 2 The quality of the produced interference is calculated.
- 3 The calculated interference is compared with stored patterns obtained under optimum operating conditions.
- 4 The difference between these interference patterns is calculated by an advanced digital signal processor.
- 5 The inclination of the fixed mirror is continuously adjusted to eliminate any difference and maintain optimum operating sampling conditions.

* Automatic Dehumidifier is working.

Reliable High Performance

Self-diagnostics and monitoring technology allow for quick, easy instrument management.

Five Self-Diagnostic Functions

▶ The IRTracer-100 executes a self-diagnosis at instrument initialization, checking the electrical, signaling, and optical systems. If the interference conditions are not optimum, they are adjusted and optimized using the Advanced Dynamic Alignment mechanism.

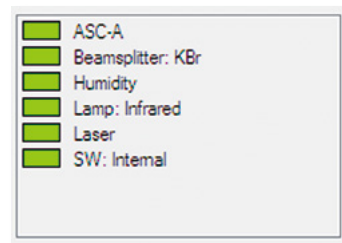

▶ The internal status monitor function offers continuous monitoring of the beam splitter type, the light source, the He–Ne laser, humidity condition, and information related to auto-start accessories.

▶ The hours*¹ used on the ceramic source and He–Ne laser as well as the time remaining before the next periodic inspection are monitored.

▶ When the beam splitter is exchanged for Near IR and Far IR analysis, the IRTracer-100 automatically detects the new beam splitter. In addition, when an accessory is installed, the accessory is automatically identified and optimum measuring conditions are automatically set*².

▶ Diagnostic and monitoring results are recorded in logs for reference.

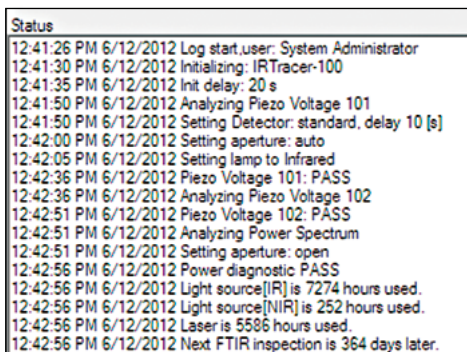
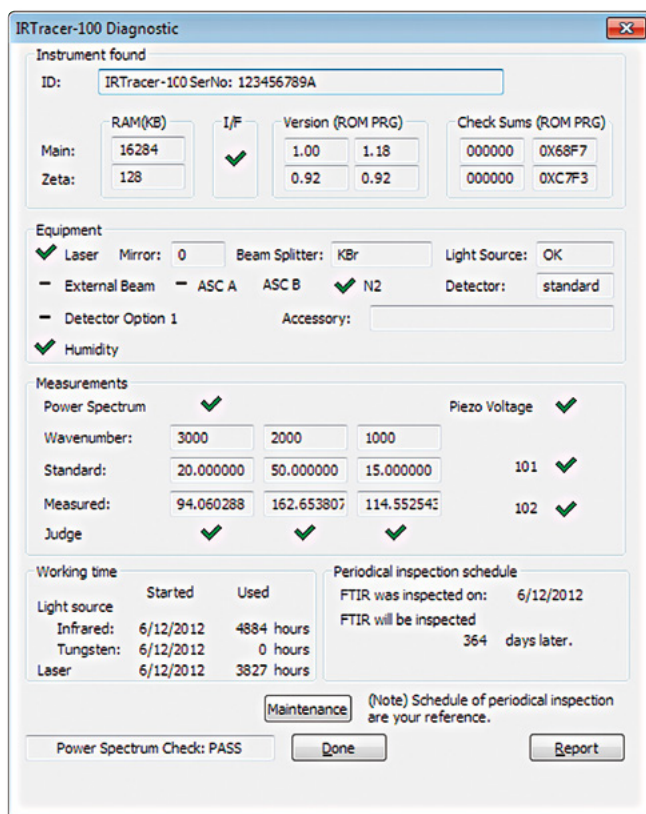

*1 3-year warranty for light source and 30-month warranty for He–Ne laser *2 Only when QuickStart accessories are installed.

Validation Program^{*)}, Verifies FTIR Performance

The IRTracer-100 is equipped with a validation program that complies with the European^{**)}, Japanese, Chinese, and U.S.^{***)} Pharmacopoeias and with ASTM (American Society for Testing and Materials) specifications. The validation program checks

the basic performance of the instrument using a polystyrene film, and creates reports of the results. If any failure is detected, simply use the Advanced Dynamic Alignment mechanism to adjust and optimize the IRTracer-100.

Test Specifications Complying with the European, Japanese, Chinese, and U.S. Pharmacopoeias

- Shape and intensity of a power spectrum
- The following specifications for a polystyrene spectrum are verified:
 - Resolution
 - Wavenumber accuracy
 - Wavenumber reproducibility
 - Transmittance (absorbance) reproducibility

Test Specifications for ASTM (ASTM E1421 Level Zero)

- Energy intensity test based on the power spectrum
- Noise test based on a 100% transmittance spectrum
- Reproducibility test based on a polystyrene spectrum

SHIMADZU IRPrestige/IRAffinity/IRTracer/FTIR-8000 Series ASTM Level 0 Report						
Instrument	: IRTracer-100		Overall Judgement	: PASS		
Serial No.	: IR 1		Temperature	: 25		
Sample name	: PS1		Relative Humidity	: 35		
Inspected by	: Admin		Date/Time	: 2012-06-12/10:01:02		
Approved by	:		Date	:		
1. ASTM Level 0 Test - Energy Spectrum Test						
Item	Today	Prev.	Error	Standard	Judge	
E(4000)/E(2000)	0.29	0.28	0.00	0.30	PASS	
E(2000)/E(1000)	1.44	1.43	0.01	0.30	PASS	
E(150)/E(max)	0.00	0.00	0.00	0.30	PASS	
at	%T	Error	Standard	Judge		
cm-1	%T	%T	%T			
4000	101.41	1.41	30.00	PASS		
2000	100.07	0.07	30.00	PASS		
1000	99.60	0.40	30.00	PASS		
500	99.43	0.57	30.00	PASS		
Ignore following bands due to water vapor (Peaks at 2200-1300cm-1, 4000-3300cm-1) and CO2 (Peaks at 2400-2250cm-1)						
2. ASTM Level 0 Test - 100%T Line Test						
W.N.	P-P	Standard	Judge			
cm-1	%T	cm-1				
4000	0.03	1.00	PASS			
2000	0.03	0.10	PASS			
1000	0.01	1.00	PASS			
500	0.32	8.00	PASS			
RMS Noise Value						
W.N.	RMS	Standard	Judge			
cm-1	%T					
4000	0.007	0.50	PASS			
2000	0.006	0.05	PASS			
1000	0.003	0.50	PASS			
500	0.071	4.00	PASS			
Average of Transmittance						
W.N.	Average	Standard	Judge			
cm-1	%T					
4000	100.20					
2000	100.03					
1000	99.99					
500	99.90					
3. ASTM Level 0 Test - Polystyrene Test						
at	%T	Standard	Judge			
cm-1	%T	%T				
4000	-1.20	+/-10.00	PASS			
2000	-0.37	+/-10.00	PASS			
1000	-0.41	+/-10.00	PASS			
500	0.88	+/-10.00	PASS			
Ignore following bands due to Strong Polystyrene bands at 3050-2850cm-1, 1550-1400cm-1, 800-650cm-1, 600-500cm-1						

SHIMADZU IRPrestige/IRAffinity/IRTracer/FTIR-8000 Series Validation Report (EP7.0)						
Instrument	: IRTracer-100		Overall Judgement	: PASS		
Serial No.	: IR 1		Temperature	: 25		
Sample name	: PS1		Relative Humidity	: 35		
Inspected by	: Admin		Date/Time	: 2012-06-12/09:51:31		
Approved by	:		Date	:		
1. Power spectrum						
Wavenumber	Measured	Standard	Judge			
cm-1	E	E				
4600.0	16.26	8.41	PASS			
4000.0	29.75	21.02	PASS			
3000.0	50.42	42.04	PASS			
at Maximum	84.08	50.00	PASS			
700.0	28.74	8.41	PASS			
500.0	11.33	1.88	PASS			
403.0	2.70	0.42	PASS			
351.0	0.16	0.01	PASS			
2. Resolution						
Wavenumber	Measured	Standard	Judge			
cm-1	ABS	ABS				
2870.0	2870.2	0.448				
2849.5	2849.9	1.024				
Peak depth(ABS)	0.576	0.33	PASS			
1589.0	1588.4	0.278				
1583.0	1582.7	0.479				
Peak depth(ABS)	0.201	0.08	PASS			
3. Wavenumber accuracy						
Wavenumber	Measured	Error	Tolerance	Judge		
cm-1	cm-1	cm-1	cm-1	cm-1		
3069.0	3069.2	0.2	+/-1.0	PASS		
2849.5	2849.9	0.4	+/-1.0	PASS		
1942.9	1942.4	-0.5	+/-1.0	PASS		
1601.2	1601.0	-0.2	+/-1.0	PASS		
1583.0	1582.7	-0.3	+/-1.0	PASS		
1154.5	1154.4	-0.1	+/-1.0	PASS		
1028.3	1028.1	-0.2	+/-1.0	PASS		
4. Reproducibility of Wavenumber						
Wavenumber	No.1	No.2	Error	Tolerance	Judge	
cm-1	cm-1	cm-1	cm-1	cm-1		
2849.5	2849.9	2849.9	0.0	+/-5.0	PASS	
1601.2	1601.0	1601.0	0.0	+/-1.0	PASS	
1028.3	1028.1	1028.1	0.0	+/-1.0	PASS	
5. Reproducibility of Absorbance						
Wavenumber	No.1	No.2	Error	Tolerance	Judge	
cm-1	ABS	ABS	ABS	ABS		
2849.5	1.024	1.026	-0.002	+/-0.03	PASS	
1601.2	1.334	1.339	-0.005	+/-0.05	PASS	
1028.3	0.869	0.873	-0.004	+/-0.03	PASS	

^{*)}: Please contact for the applicable version. ^{**)}: The Indian Pharmacopoeia has been unified with the European Pharmacopoeia. ^{***)}: The United States Pharmacopoeia states that validation should be performed according to the method specified by the equipment manufacturer.

New Generation of Workstation

LabSolutions IR, a member of the LabSolutions family, has been optimized for network applications, includes an extensive library of spectra, and features a high-performance search function. In addition, Macro functions provide automation and labor savings.

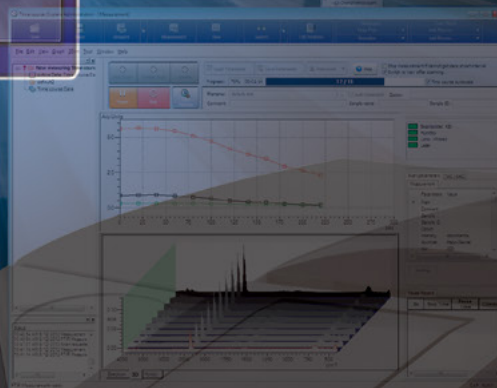
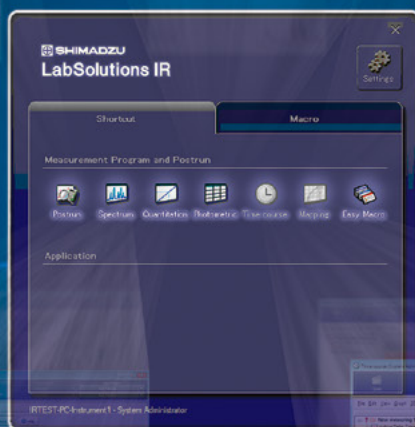
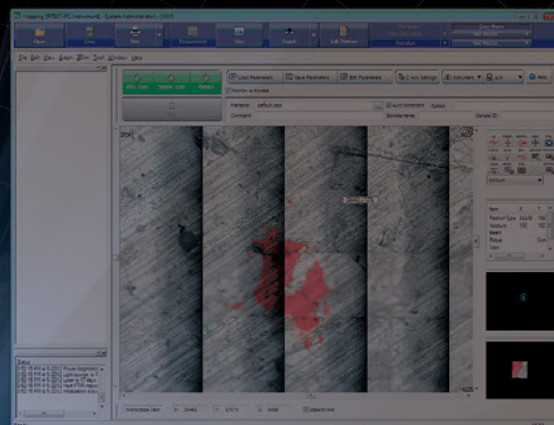
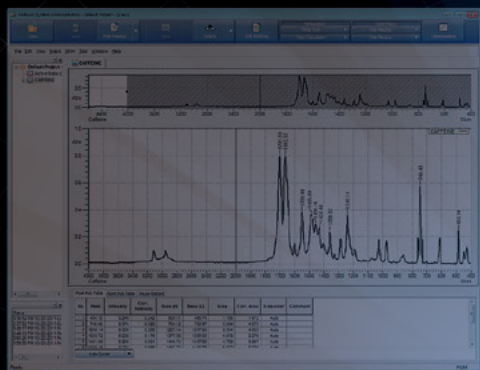

IRTracer-100
SHIMADZU

Fast, Easy-to-Use LabSolutions IR Series Software

LabSolutions IR easily executes FTIR operations such as scanning, data manipulation, quantitation, reporting, saving, user administration, and more. High-level administrative functions and a variety of data manipulation functions provide for an easier, more user-friendly analysis environment. In addition, numerous optional programs are available to address all modern laboratory needs.



Launcher

Run Dedicated LabSolutions IR Programs or Windows® Applications Easily with the Dedicated LabSolutions IR Launcher.

LabSolutions IR includes a number of dedicated programs, including Postrun, Spectrum, and Quantitation, which are easily launched using the LabSolutions IR Launcher. In addition, macro programs and Windows® applications can be registered with the LabSolutions IR Launcher for quick and easy start-up.

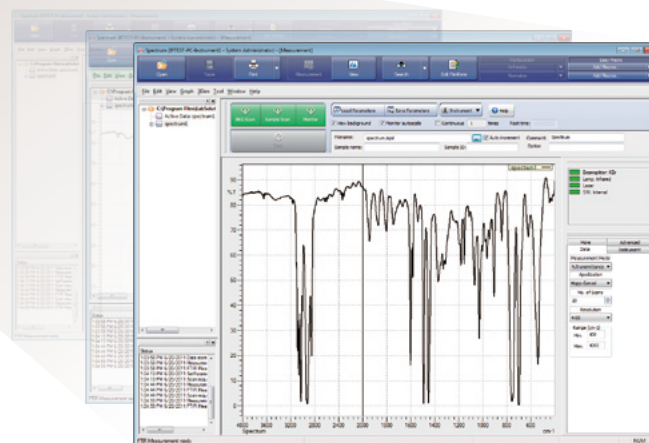

Excellent Features of LabSolutions IR Series

Network Features

- ▶ High-level security and user administration functions.
- ▶ Suitable for ER/ES regulations such as FDA 21 CFR Part 11, PIC/S, and more.
- ▶ Management of FTIR as well as LC and GC data by the server on a network.

Extensive Spectra Library and High-Performance Search Function

- ▶ Features a library containing approximately 12,000 spectra.
- ▶ Enables high-quality searching with standard libraries.
- ▶ High-performance search methods, including Spectral, Text, Combination, and Peak searches.
- ▶ Shimadzu's unique search algorithm provides precise search results.

Macro Program Functions Provide Automation and Labor-Savings

- ▶ Simply align steps to create a Macro program.
- ▶ Automated identification tests and contaminants analysis.

Programs

- ▶ Postrun, Spectrum, Quantitation, Photometric, Time course (option), Mapping (option)
- ▶ All of the Postrun and measurement programs have a common Main toolbar, Menu, Measurement toolbar, Tree view, and Log window. The operation of each program is also similar, providing a familiar feel no matter what task you are working.

Reporting

- ▶ Easy printing using the ViewPrint function and Free-layout reports.

Data Manipulation

- ▶ A wide variety of data manipulation functions, including Advanced ATR correction and Kubelka–Munk conversion, and quantitation functions, such as the multi-point calibration curve method and CLS method, are standard.

Solutions Achieved with LabSolutions

Reliable LabSolutions Software

In addition to LabSolutions IR, which provides basic functionality, Shimadzu also offers LabSolutions DB IR and LabSolutions CS IR to meet the requirements of ER/ES regulations.

LabSolutions DB IR

LabSolutions DB IR allows for secure data management by integrating a data management function with LabSolutions IR. Compliant with ER/ES regulations, the software is optimally configured for customers using a PC. It is recommended for facilities that do not require network connections and want to be ER/ES compliant.

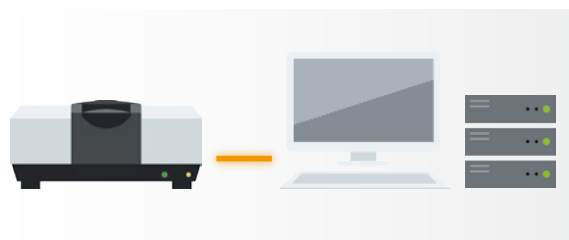

LabSolutions CS IR

LabSolutions CS, which is freely accessible to the analysis network, can be connected to IR, eliminating the need for connecting a PC to the instrument. Since all the data are managed on a server, LabSolutions CS IR can be read from any personal computer on a network. With terminal service, LabSolutions IR can be controlled from a client PC without installing LabSolutions IR on it. It is recommended for facilities that have a large number of users, manage data in a database, and want to be ER/ES compliant.

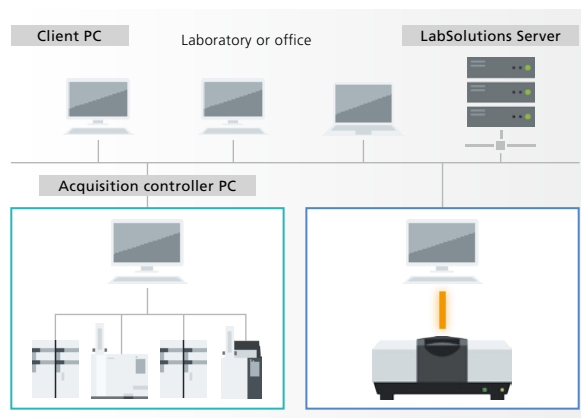

Name	LabSolutions IR	LabSolutions DB IR	LabSolutions CS IR
Data management method	Measured data files are saved and managed in folders on the PC.	Measured data files are saved and managed in the LabSolutions database.	
Data references	The software references files on drives or in folders on the PC.	The software references files in the database.	
LabSolutions database	Unavailable	Available (The database resides on a local PC)	Available (The database resides on a server)
User administration	Available		
Rights group administration	Available		
Project administration	Unavailable	Available	
Standalone/network	Either can be used.	Only the standalone configuration can be used.	Only databases on the network can be used. (LabSolutions IR data can be viewed using the database manager on a PC set up for viewing purposes. Note that LabSolutions IR must be installed on the PC used for viewing.)
Data backup	Performed on a file-by-file basis using Windows® Explorer.	Performed for each database.	

Operate with LabSolutions, Shimadzu's reliable and popular workstation used in chromatography and spectroscopic analysis.

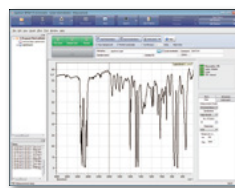

Spectral Measurement Screen



Database Management Prevents Mistakes

With LabSolutions DB IR and CS IR, the analysis data are managed securely by the database. Overwriting, deletion and other mistakes typical of data file management do not occur.

In addition, when postrun analysis is performed using the acquired data, postrun analysis data revision numbers are automatically assigned, preventing the accidental overwriting of raw data.

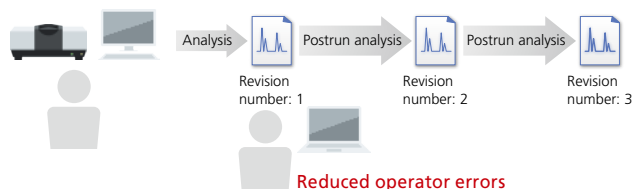

Solid Security

An audit trail to ensure the reliability of data and document e-mail transmission functions when any event occurs in the system can be set up. User accounts are managed using passwords, where password length, complexity and term of validity must satisfy specified requirements. It is

also possible to set lockout functions to prevent illegal access, and set a registered user's deletion and change. In addition, a box can be selected to prevent overwriting a data file, and outputting an item to a report can also be performed.

Pertinent Information is Managed for Every Project

LabSolutions DB IR and CS IR provide a project management function enabling management suited to tasks and system operations. This function enables equipment and user management, security policy, and data processing to be set on a project by project basis, thereby improving the efficiency of data searches and management tasks.

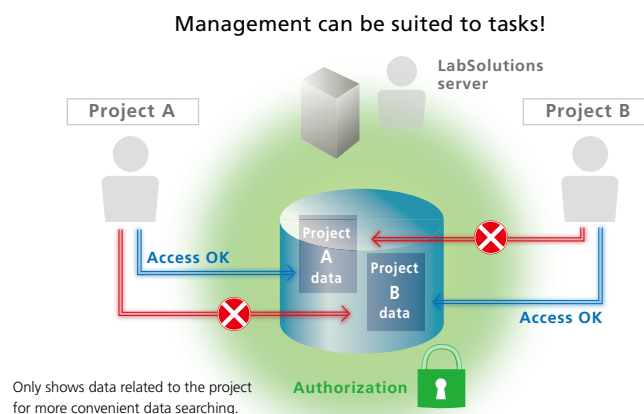

Visualization of the Sequence of Analysis Operations

Creating a report set* provides visibility of the individual analytical operations involved in the overall analytical process. When analytical operations are visible, it is easier to check for operating errors, which helps improve the efficiency and reliability of checking processes.

* Report sets include test methods and test results for a series of samples analyzed, and also a corresponding operation log (a record of all operating events from login to logout), which is automatically extracted from the data and summarized in a single report.

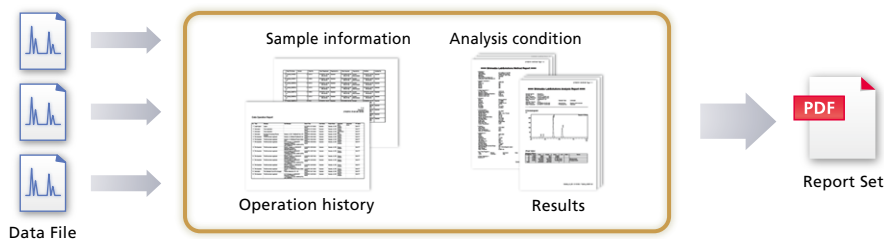

Extensive Spectra Library and a High-Performance Search Function

Features a library containing approximately 12,000 spectra.
Enables high-quality searching with standard libraries.

Approx. 12,000-spectra library

A wide variety of libraries, including Shimadzu's unique libraries, reagents, polymers and more, is included standard. Searching with standard libraries provides high-quality search results without purchasing extra libraries.

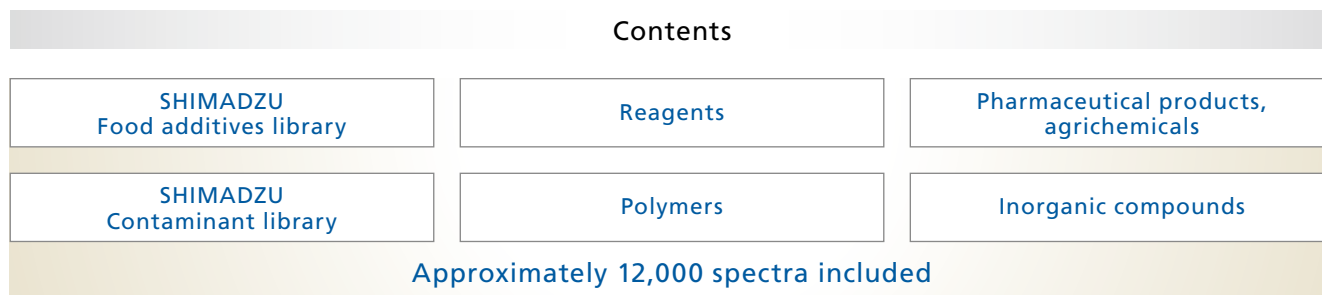

High-Performance Search Functions

Obtain high-quality search results with four high-performance search methods (spectral search, peak search, text search and combination search) and a library containing 12,000 spectra.

Libraries created on IRsolution and HYPER-IR and commercial libraries such as Sadtler and S.T. Japan can also be used.

Simply dragging spectra into a library creates a user library. In addition, editing spectral information or deleting a spectrum is very easy.

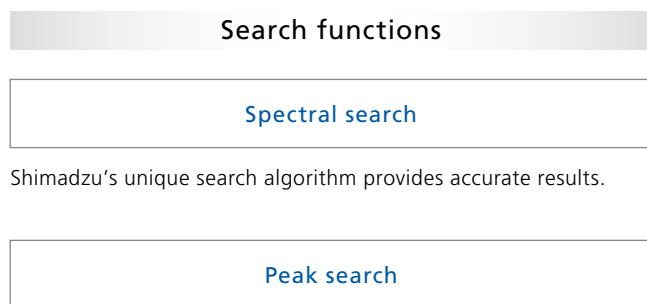

Shimadzu's unique search algorithm provides accurate results.

If you only have an old spectrum chart, searching can be performed with peak wavenumbers without a spectrum file.

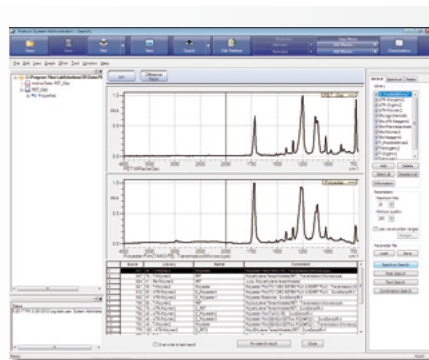

Other Optional Libraries

- Contaminant Library for LabSolutions IR

This is Shimadzu's original library. It is an effective tool for analyzing contaminants in tap water and food.

- UV-Damaged Plastics Library

Unlike existing libraries, this library contains data of degraded plastics that have been oxidized by UV-rays.

- Thermal-Damaged Plastics Library

Unlike existing libraries, this library contains data of degraded plastics that have been oxidized by heating.

Please refer to page 27 for more information of libraries.

Automation and Labor-savings with Macro Program Functions

LabSolutions IR automates routine work, such as scanning, data manipulation, reporting, identification tests, and contaminants analysis.

Launch programs from the Launcher or your PC desktop.

Easy Macro—Just a Single Click Launches Routine Work

The “Easy Macro” function will create macros that are suitable for routine work, particularly when repetitive operations are used. The macro builder allows macros to be constructed by simply selecting and aligning operations from a list. Once constructed, the macros can be registered with the Launcher and Desktop for quick execution.

Operators who are not familiar with FTIR can easily operate the instrument.

Easy Macro Operations

- ▶ Initialization of FTIR, configuration of scan parameters, spectrum measurement
- ▶ Data manipulations, search, quantitation, printing
- ▶ Repeat measurements, displaying messages, alarm sounds, external program execution

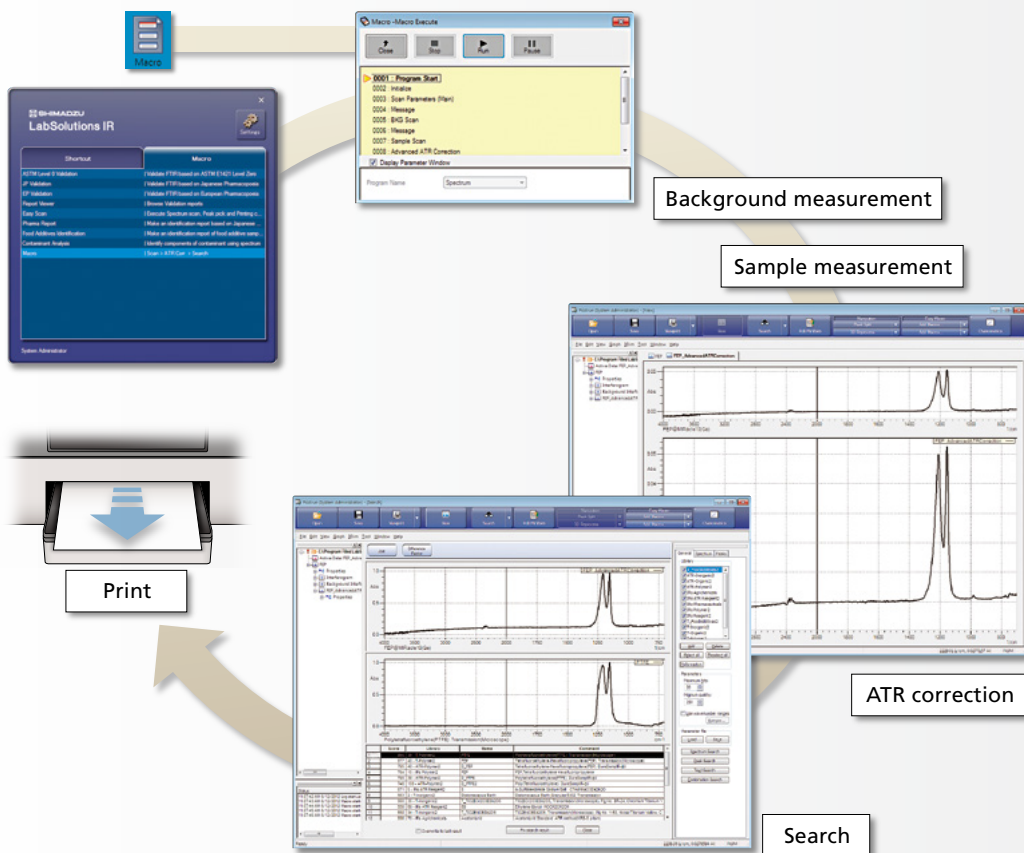
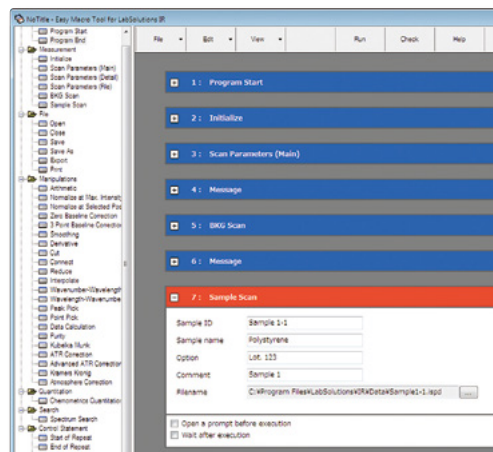

Meeting the Needs of a Wide Range of Analyses

A wide variety of programs and accessories is available in order to meet the needs of various customers.

Customize Your Own IRTracer-100 System

You can customize your own IRTracer-100 system with a wide variety of accessories and easy-to-use software options to meet the needs of your specific application.

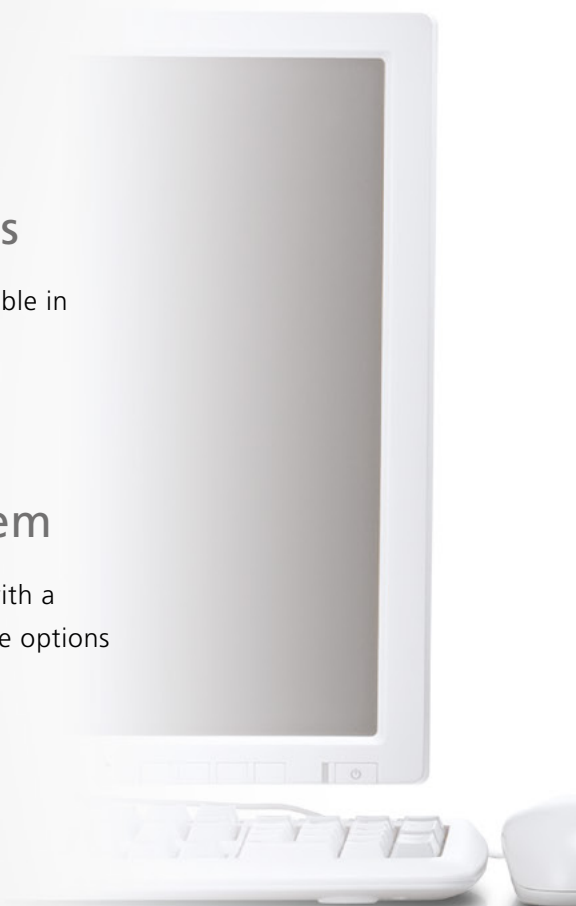

Meeting the Needs of a Wide Range of Analyses



Pharmaceuticals

- Raw material identification tests
- Identification of functional groups of synthetic products
- Identification of functional groups of natural products
- Analysis of contaminants

Cosmetics

- Material identification tests
- Analysis of contaminants
- Failure analysis

Food Products

- Raw material identification tests
- Packaging material identification tests
- Analysis of contaminants

Environmental

- Water analysis
- Soil analysis
- Exhaust gas analysis
- Measurement of particles in water or air
- Analysis of asbestos
- Oil in water analysis

Chemicals and Polymers

- Raw material identification tests
- Qualitative analysis of plastics and rubber
- Identification of functional groups of synthetic products
- Analysis of surface preparation agents
- Analysis and thickness measurement of thin films
- Analysis of catalysts
- Analysis of paints and coatings
- Analysis of contaminants
- Quantitative analysis
- Recycle





Electrical, Electronics, and Semiconductors

- Thickness measurement of epitaxial films
- Quantitative analysis of interstitial oxygen and substituted carbon
- Quantitative analysis of phosphorus and boron in BPGS
- Quantitative analysis of hydrogen concentration in nitride film
- Quantitative analysis of hydrogen concentration in amorphous silicon
- Detection of brominated flame retardants (RoHS)
- Analysis of thin films
- Analysis of contaminants
- Failure analysis
- Analysis of semiconductor gases
- WEEE

Automobiles

- Material identification tests
- Analysis of contaminants
- Failure analysis

Metals

- Qualitative analysis of thin films on metal plates
- Analysis and thickness measurement of thin films
- Analysis of contaminants

Construction

- Material identification tests
- Degradation analysis of coatings

Academia

- Research & Development
- Educational laboratories

Various Application Programs Support All Analyses

LabSolutions IR includes two main application programs—for contaminant analysis and identification tests. Even operators unfamiliar with FTIR analysis can easily use these programs and create reports in just a few seconds.

Contaminant Analysis Program

Combining Shimadzu's own algorithms (patent pending) with that of library spectra for common contaminants, this program identifies contaminants with a high degree of accuracy. This easy-to-use program is conducive to all levels of operators. Reports are automatically created after analysis, allowing operators with little knowledge of infrared analysis to easily perform analysis.

Four Features of the Contaminant Analysis Program

Contains spectra for over 550 inorganic substances, organic substances, and polymers that are often detected as contaminants in Shimadzu's Analytical Applications Department.

Incorporates algorithms that focus on spectral characteristics, rather than performing simple spectrum searches.

Automates the process, including searching, judgment evaluation, and report creation.

Finds major and minor components and displays their ranks.

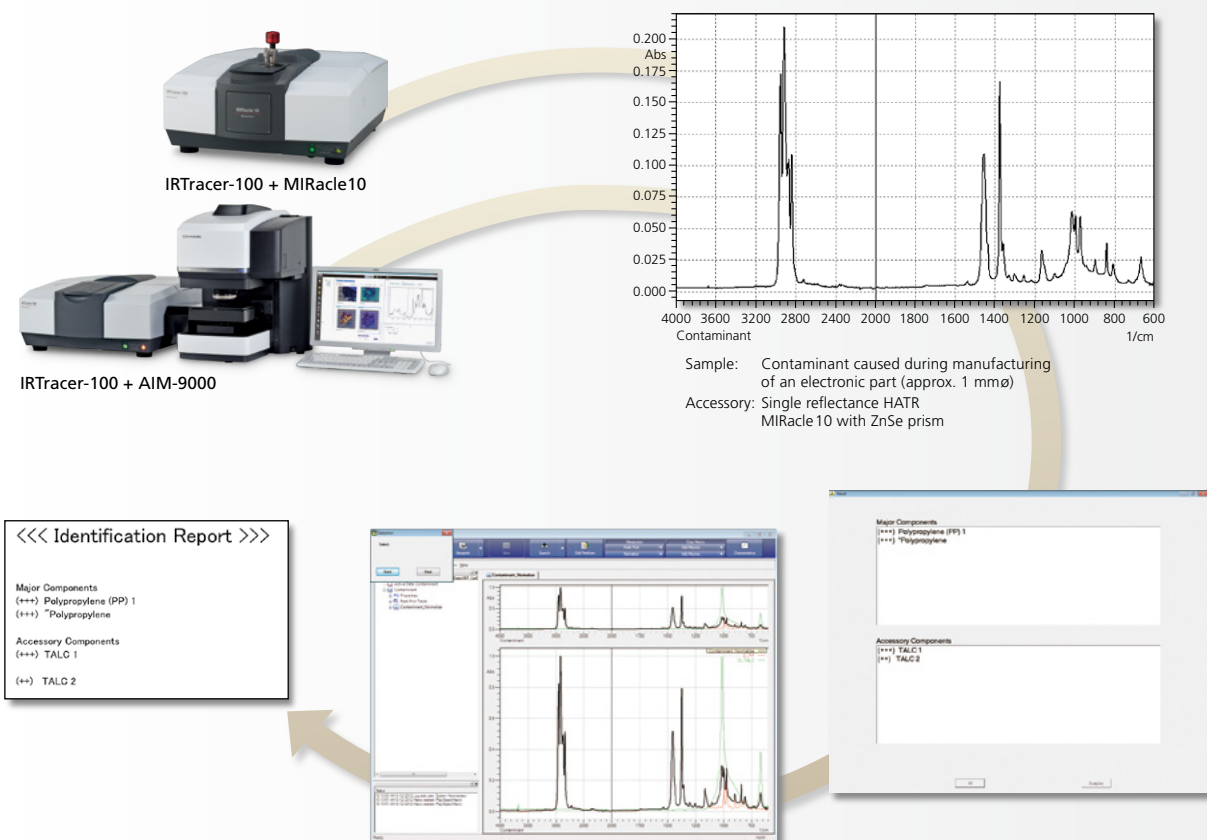

Identification Test Program

This program makes pass/fail judgments about samples in accordance with the tests specified in the Pharmacopoeia. In addition to identification tests for pharmaceutical products, this program can be used for incoming and pre-shipment inspections.

Four Features of the Identification Test Program

Prints out the spectra for standards and samples to facilitate easy comparison.

Detects and prints just the peaks that are specified for pass/fail judgment.

Calculation of the differences between the peak wavenumbers for standards and samples, differences in intensity ratios between peaks, pass/fail judgments, and print out of reports.

Contains spectra of 57 samples of Japanese Standards of Food Additives in LabSolutions IR.

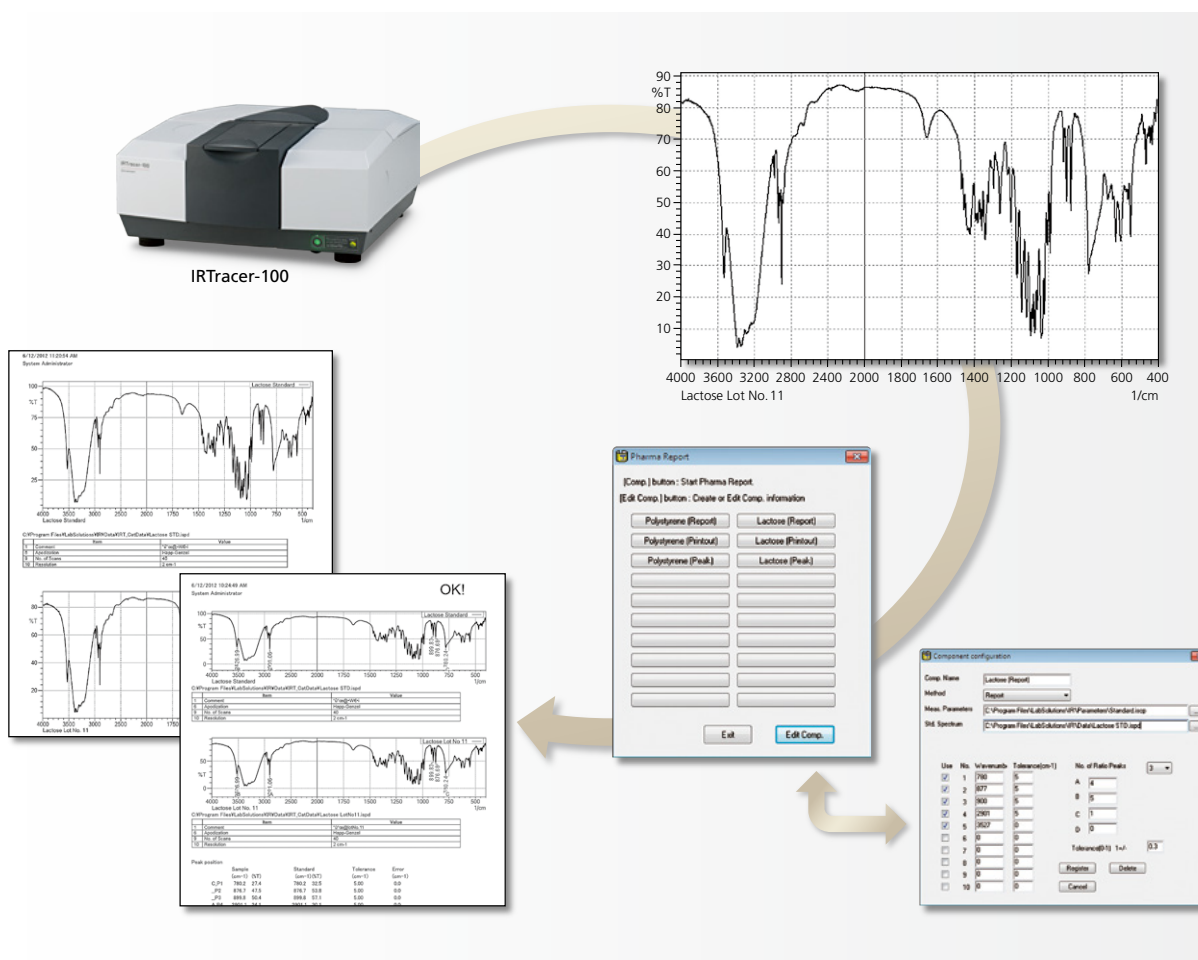



EDXIR-Analysis software is specially designed to perform qualitative analysis using data acquired by an energy dispersive X-ray (EDX) fluorescence spectrometer and a Fourier transform infrared spectrophotometer (FTIR).

This software is used to perform an integrated analysis of data from FTIR, which is excellent at the identification and qualification of organic compounds, and from EDX, which is excellent at the elementary analysis of metals, inorganic compounds and other content. It then pursues identification results and the degree of matching. It can also be used to perform EDX or FTIR data analysis on its own.

The library used for data analysis (containing 485 data files) is original to Shimadzu, and was created through cooperation with water supply agencies and food manufacturers.

Additional data can be registered to the library, as can image files and document files in PDF format. It is also effective for the linked storage of various types of data as electronic files.

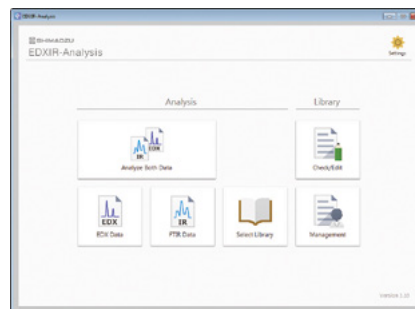

Integrated Analysis of Contaminant Data and Data Comparisons for Confirmation Tests

To perform qualitative analysis automatically, simply click “Analyze Both Data” and select the EDX/FTIR data*1. This heightens the efficiency of data analysis and provides strong support for contaminant analysis.

In addition to a list of hits, the integrated data analysis results show EDX profiles and FTIR spectra found as hits from the library. If the user wishes to browse the respective data analysis results, they can be checked by clicking “Single”.

In addition, with the data comparison function, which calculates the degree of matching between the actual measured data and the data registered in the library, the software can be used for countermeasures against “silent change”*2 and for other confirmation tests.

Clicking the “Print” button prints the results in a fixed format

and also saves them in Word format*3.

The examples here show an integrated analysis of black rubber contaminant data and a data comparison for a polyvinyl chloride (PVC) examination object and the standard product. From the integrated data analysis results, it is evident that the black rubber contaminant is acrylonitrile–butadiene rubber (NBR), which contains calcium carbonate and zinc stearate. In addition, from the data comparison, the degree of matching between the PVC examination object and the standard product is 0.8506. Lead (Pb) and acrylic were detected from the EDX and FTIR data, but not detected in the standard product. Accordingly, it is surmised that the examination object contains components different to those in the standard product.

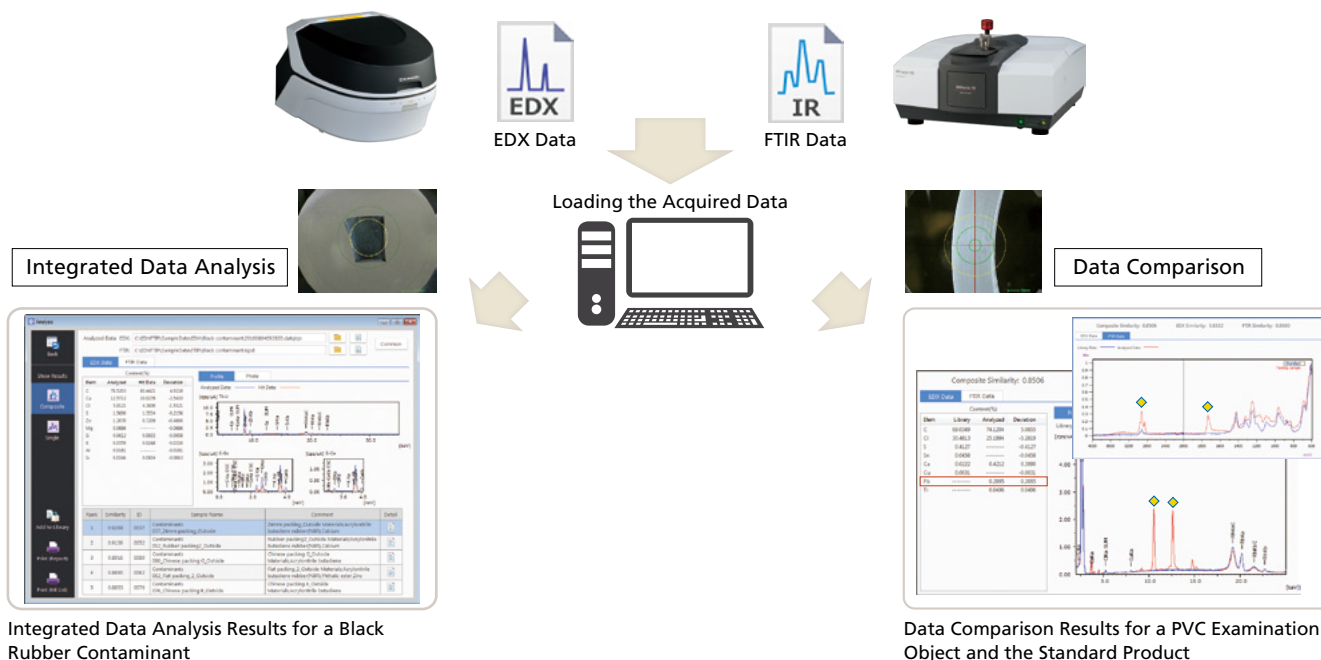

Integrated Data Analysis Results for a Black Rubber Contaminant

Data Comparison Results for a PVC Examination Object and the Standard Product

*1 Using the EDX profile, data are classified as inorganic, organic, and mixture. Integrated data analysis is performed by applying priority levels to each classification. (Patent pending)
 *2 A term used in Japan to indicate changes to materials by suppliers without the knowledge of the manufacturers. *3 Microsoft® Word must first be installed.

Data Browsing and the Registration, Editing, Deletion of Data, Images, Document Files

By clicking “Edit” and selecting an existing library, the data, images and documents registered in the selected library can be browsed. Data can be newly registered, edited and deleted. A new library can also be created. In addition, if data for a sample were acquired by instruments other than EDX and FTIR instruments (such as a chromatograph, mass spectrometer, or surface observation system), it can be converted into PDF format and then registered, enabling linked storage to the EDX/FTIR data.

Edit

ID	Sample Name	Comment	EDX Date	EDX Data
0008	Sample Name	Comment		
0009	Sample Name	Comment		
0010	Sample Name	Comment		
0011	Sample Name	Comment		
0012	Sample Name	Comment		
0013	Sample Name	Comment		
0014	Sample Name	Comment		
0015	Sample Name	Comment		
0016	Sample Name	Comment		
0017	Sample Name	Comment		
0018	Sample Name	Comment		
0019	Sample Name	Comment		
0020	Sample Name	Comment		
0021	Sample Name	Comment		
0022	Sample Name	Comment		
0023	Sample Name	Comment		
0024	Sample Name	Comment		
0025	Sample Name	Comment		
0026	Sample Name	Comment		
0027	Sample Name	Comment		
0028	Sample Name	Comment		
0029	Sample Name	Comment		
0030	Sample Name	Comment		

EDX Profiles, Quantitation Results, EDX Photographs, Comments, and Other Information

Photographs, Document Files, Comments, and Other Information

Browsing Registered Photographs

Browsing Document Files

FTIR Spectra and Comments

All Data Are Linked and Stored

Sample Holder/Stocker for Contaminant Measurement EDXIR-Holder™ (Option)

Measure the Samples Kept in the Holder with EDX and FTIR
The Holder Can Be Used as the Sample Stocker after the Measurement

Enables More Efficient Analyses

This foldable holder consists of adhesive layer with samples attached and polypropylene film designed for fluorescence X-ray. When using EDX for measurement, close the holder and place the polypropylene film directly to the irradiation side (downside). When using FTIR for measurement, open the holder and press the samples attached to the adhesive layer against the ATR prism. This enables the replacement of samples, at a minimum, saving on labor and making analysis more efficient.

Prevents Loss of Samples

Close the holder after the measurement and it can be used as a sample stocker. It is not necessary to transfer the samples to other containers, so there is no danger of losing samples.

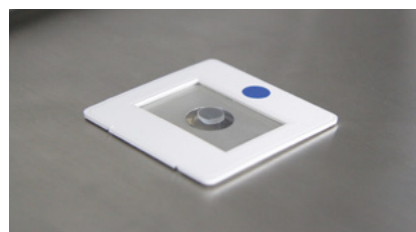

How to Use with EDX

Close the holder and place the polypropylene film to the irradiation side (downside).

Polypropylene Film Designed for Fluorescence X-ray



Adhesive Layer

Attach the Samples

When the Holder is Open (Inside of the Holder)

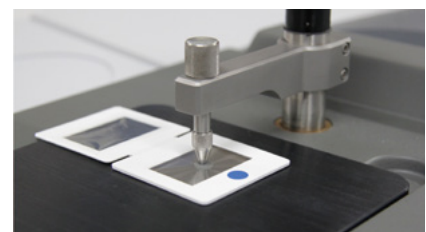

How to Use with FTIR

Open the holder and press the samples attached to the adhesive layer against the prism.

Hardware Options

Integrated with sample compartments, the series of horizontal ATR accessories offers improved purging performance, and eliminates the concern of dust entering the IRTracer-100's sample compartment. When an accessory is installed, the software displays its name and serial number and sets the optimum scan parameters.

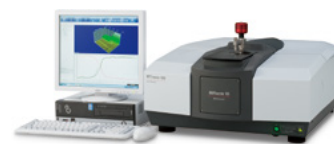

MIRacle™ 10

(P/N 206-74127-9x)

This is a single-reflection ATR accessory. To measure the spectrum of a liquid, simply place it on the surface of the prism drop-wise. Measure solid samples by simply clamping them onto the surface of the prism using the provided pressure clamp. In addition, the MIRacle-10 enables easy measurement of large samples (with a large surface area) without compromising sample integrity. The incidence angle is 45°. Select from three prism options: ZnSe, Ge, and diamond/ZnSe, and whether the prism is equipped with a pressure sensor. The Ge prism is ideal for samples with a high refractive index.



Powders



Moldings



Thin Films



Films



Liquids



Rubber



GladiATR 10

(P/N 206-74128-9x)

This is a single-reflection ATR accessory. Because the prism is made solely of diamond, it is capable of measuring spectra down to 400 cm^{-1} . To measure the spectrum of a liquid, simply place it on the prism drop-wise. To measure the spectrum of the surface of other samples, clamp them firmly on the surface of the prism. The incidence angle is 45° and you can select whether the prism is equipped with a pressure sensor.



Powders



Moldings



Thin Films



Films



Liquids



Rubber

HATR 10

(P/N 206-74126-91)

This is a horizontal ATR accessory. There are flat prisms for solids and troughs for liquids. To measure the spectrum of a liquid sample, simply place it on the prism drop-wise. To measure the spectrum of the surface of film and rubber samples, clamp them firmly on the surface of the prism. The incidence angle is 45°, and the number of reflections is ten. It includes a ZnSe prism as standard; use an optional Ge prism for samples with a high refractive index.



Films



Liquids



Rubber

DRS-8000A

(P/N 206-62301-58)

Although powder samples are mixed with KBr, as with the KBr pellet method, the DRS-8000A analyzes the samples in their original state; creating pellets is not necessary. For plastic moldings, emery paper attached to the SiC sampler (P/N 200-66750-01) scrapes off part of the surface, forming a powdered sample that can be analyzed. Easily obtain diffuse reflectance spectra similar to transmittance spectra using the built-in Kubelka–Munk conversion in the LabSolutions IR software.



Powders



Moldings



SiC sampler

SRM-8000A

(P/N 206-62304-58)

Use this specular reflectance accessory, featuring a 10° incidence angle, for the analysis of thin films on a metal plate with a μm order of thickness. For mirror-like plastic samples, it measures the specular light reflected from the sample surface. Kramers–Kronig analysis, available with LabSolutions IR software, produces specular reflectance spectra similar to transmittance spectra.



Thin Films



RAS-8000A

(P/N 206-62302-58)

Use this high-sensitivity reflection measurement accessory, featuring incidence angles of 70° and 75°, for the analysis of thin films on a metal plate with a nm order of thickness. Using it in combination with the GPR-8000 infrared polarizer (P/N 206-61550-58) enables measurement with an even higher level of sensitivity.



Thin Films



GPR-8000

ATR-8000A

(P/N 206-62303-58)

This accessory obtains spectra for the surfaces of film-like samples that are clamped firmly on the surface of a prism. Incidence angles of 30°, 45°, and 60° can be selected. The KRS-5 prism is standard. A Ge prism is also available for samples with a high refractive index.



Films



Rubber

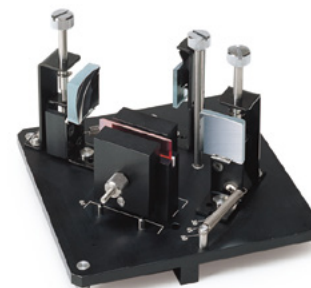

* ATR spectra similar to transmittance spectra are produced by ATR correction.

Infrared Microscope AIM-9000

(P/N 206-32000-58 (Narrow band MCT))

The AIM-9000 incorporates a bright, optimized optical system and a high-sensitivity MCT detector. Not only enabling high-sensitivity measurement of micro samples, but the system has also been automated to ensure all steps involved in micro analysis can be performed quickly and easily.

Features of the AIM-9000

- ▶ Incorporates a bright, optimized optical system and a high-sensitivity MCT detector to enable high-sensitivity measurement.
- ▶ Enables reflection/ATR measurements on samples up to 40 mm thick.
- ▶ Comes with a digital zoom function of up to 330× magnification using the wide-view camera (optional) and the microscope camera. Enables the measurement position to be quickly determined.
- ▶ Includes an automatic contaminant recognition system that automatically determines the measurement position as a standard feature.
- ▶ Up to 60 measurement position can be recorded.
- ▶ Includes a contaminant analysis program to identify the cause of failures as a standard feature.



Minute Samples

Note: In order to use this attachment, an external beam extraction kit (P/N 206-32570-42), an AIM connection kit (P/N 206-32607-42), and accessories for the AIM-9000 (P/N 206-32799-xx) are required.

ATR Objective

(Ge prism: P/N 206-32600-41)

This objective lens is used when performing ATR measurements with the AIM-9000 infrared microscope. Using a cone-type prism, this single reflection objective features 15× magnification and a 45-degree mean incident angle. The slide-on type prism makes it easy to switch back and forth between visible observation and infrared measurement.

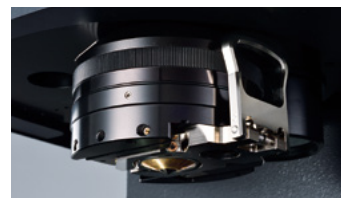

Minute Samples

Mapping Program (AIMsolution)

(P/N 206-32936-41)

The mapping program measures the absorption distribution on the surface of a sample and creates imaging data when used with the Shimadzu AIM-9000 infrared microscope.

It allows setting of mapping parameters, such as the mapping range, the scan intervals, and the background positions, on the composite visible images. It also supports area mapping and random mapping modes. In addition to mapping in the conventional transmittance and reflectance modes, micro-ATR mapping is also available. (An optional ATR objective is required. It also requires a separate pressure sensor.) From the acquired mapping data, it is possible to extract spectra and to perform calculations for specific peaks and functional group mapping by multivariate analysis.

5-cm Gas Cell (P/N 202-32006-xx)

10-cm Gas Cell (P/N 202-32007-xx)

Long-Path Gas Cell

Gas cells are used for analysis of gas samples, and the path length is selected based on the concentration of the samples. Gas cells with short path lengths of 5 or 10 cm and long path lengths of 10 m or more are available. Please contact your Shimadzu representative for details on long-path gas cells.



5-cm Gas Cell



Long-Path Gas Cell



Gases

MCT Kit

(P/N 206-36050-58)

Use a high-sensitivity MCT detector for analyses where a large amount of light is not available, such as monomolecular film analysis on metal substrates, high-speed reaction tracking, and low-concentration gas analysis using a long path-length gas cell. The kit installs an MCT detector on the IRTracer-100. Switching

between the standard DLATGS detector and the MCT detector is performed automatically from LabSolutions IR. In addition, the software has a built-in liquid nitrogen sensor to terminate current flow when the detector element is not being cooled, thus protecting the MCT detector.

Note: This kit cannot be mounted at the same time as the Near IR Kit (P/N 206-74253-58). Liquid nitrogen is required when using the MCT detector.

Far IR Kit

(P/N 206-30616-58)

Bands related to inorganic compounds and organometallic complexes are typically observed in the far infrared region to 240 cm^{-1} . The Far Infrared Kit contains a CsI beam splitter that can be mounted on the IRTracer-100 for measuring spectra in this region.

Since absorption due to water is greater in the 400 cm^{-1} to 240 cm^{-1} , the instrument should be purged with desiccated air before performing measurements. The CsI beam splitter should also be stored in a desiccator when not in use since it is highly sensitive to moisture.

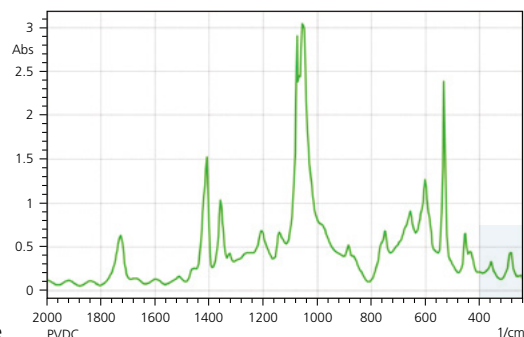

Spectrum of Polyvinylidenechloride

Near IR Kit

(P/N 206-74253-58)

Attached to the IRTracer-100, this kit enables near-infrared measurement. LabSolutions IR switches between the mid-infrared and the near-infrared.

[Specifications]	▶ Measurement Range:	12,500 to 3,800 cm^{-1}
	▶ Beam Splitter:	Si/CaF ₂
	▶ Light Source:	Tungsten iodine lamp
	▶ Detector:	InGaAs

Note: This kit cannot be mounted at the same time as the MCT Kit (P/N 206-36050-58).

NIR Integrating Sphere IntegratIR A

(P/N 208-97272-92)

- ▶ Powders, tablets, liquids, fibers, plastic pellets and molded samples can be placed on the sample stage for measurement (reflectance measurement).
- ▶ Pre-treatment such as KBr dilution is not required.
- ▶ Samples stored in a plastic bag or glass bottle can be measured.
- ▶ Applications include qualitative or identification tests in acceptance inspections and quantitative analysis of components in measured samples.
- ▶ Features a built-in highly sensitive InGaAs detector.

Note: The IntegratIR installation kit (P/N 206-72715-93) must be purchased separately.



For Other Accessories

Please contact your Shimadzu representative about accessories that do not appear in this brochure. Also note that it may not be possible to use FTIR-8000 Series accessories. Please consult your Shimadzu representative for assistance with using FTIR-8000 Series accessories.

Software Options

Fast, easy-to-use LabSolutions IR can be equipped with a variety of optional software programs and applications. LabSolutions IR incorporates data processing functions such as advanced ATR correction, degree of coincidence, differential spectra, and Kubelka–Munk conversion, quantitation functions such as the multi-point calibration curve method and the multi-regression method, as well as the spectral searching function as standard features. However, adding the following optional software products makes it possible to further increase the application range.

Rapid Scan

(P/N 206-30200-91)

The Rapid Scan option provides the capability of collecting and recording a maximum of 20 spectra/second. This is especially suitable for fast reactions kinetics, where reactions are completed in a few seconds.

Spectra obtained from Rapid Scan measurements can be used to calculate peak heights and areas, which are used to determine kinetic rates.

The Rapid Scan interval is dependent on the resolution, number of scans, and mirror speed. The fastest speed under a 16cm^{-1} resolution and a mirror speed of 40mm/s is 0.05 seconds for 1 accumulated scan. Maximum measurement time depends on scan parameters.

The 3D Processing Program (P/N 206-74563-91) is required for analysis of Rapid Scan spectra.

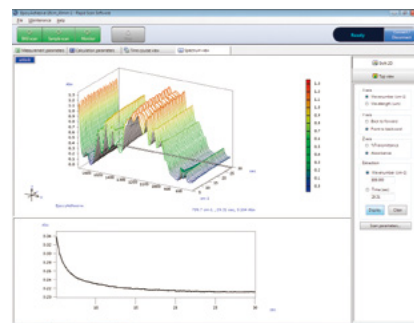

LabSolutions IR

Time Course Software

(P/N 206-74558-91)

The time course program is used to collect spectra in regular intervals and creates a time course dataset used to follow reactions as a function of time. Changes in peak height and peak area can be used to calculate values related to reaction kinetics. Time course information is saved and displayed in 3D (bird's eye view) or in a contour plot. Simply modify parameters to recalculate the information.

The scan interval is dependent on resolution, number of scans, and mirror speed. The fastest speed under a 16cm^{-1} resolution and a mirror speed of 9mm/s is 7 seconds for 1 accumulated scan. Maximum measurement time is 48 hours but it depends on scan parameters. The time course software includes a 3D Processing Program.

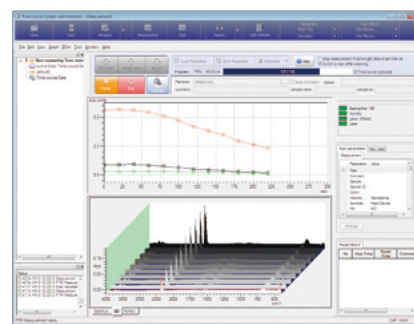

LabSolutions IR

Mapping Program

(P/N 206-74559-91)

The Mapping software allows mapping of absorption information on a sample surface as a function of position when using the Shimadzu AIM-8800 Infrared Microscope. The program allows setting of mapping parameters, such as the mapping range, the scan intervals, and the background positions, on the composite images. In addition, it supports area mapping, line mapping and random mapping modes.

In addition to mapping in the conventional transmittance and reflectance modes, micro-ATR mapping with an optional ATR objective is also available. From the acquired mapping data, it is possible to extract spectra and to perform calculations for functional-group mappings for specific peaks. The data can be displayed as 3D images or contour plots, or in spectral overlay mode.

This program includes a 3D Processing Program.

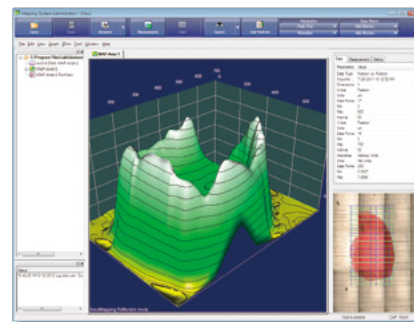

LabSolutions IR

Macro Platform

(P/N 206-74562-91)

The Macro Platform is required to run the customized macro programs created by Shimadzu (for a fee). If, for example, you wish to perform more advanced applications in which certain functions are used in a pre-determined order, or you wish to run an automatic measurement system in combination with an auto sample changer, please contact your Shimadzu representative for details.

LabSolutions IR

PLS Quantitation Program

(P/N 206-74560-91)

Like multiple linear regression analysis, PLS (partial least squares) is a chemometrics method widely used for the simultaneous quantitation of multiple components. The PLS quantitation program incorporates PLS I and PLS II methods. It is possible to display calculation values based on input values. PLS factors are based on "PRESS" values, loading vectors, and score values. Analysis can be performed on the regression equations obtained with the PLS method.

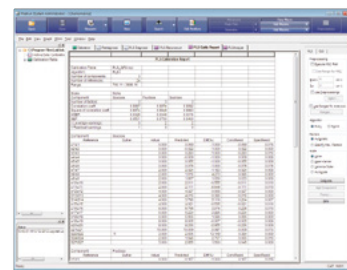

LabSolutions IR

Curve-Fitting (Peak-Splitting) Program

(P/N 206-74561-91)

Usually, absorption bands in infrared spectra consist of overlapping peaks. The curve-fitting (peak-splitting) program can be used to separate absorption bands into individual peaks, separate peaks that have been influenced by hydrogen bonding, and identify the peaks of functional groups that are hidden by absorption bands. Six types of curves, including Gaussian, Lorentzian, and Gaussian+Lorentzian, are available for separation analysis. The curve can be selected in accordance with the form of the peaks in the absorption band. The separated component peaks are displayed together with the resultant spectra making it possible to evaluate the separation accurately.

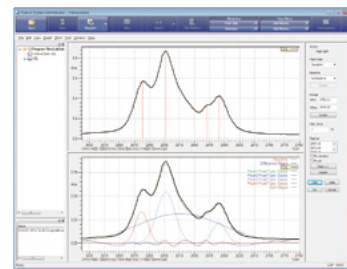

LabSolutions IR

3D Processing Program

(P/N 206-74563-91)

The 3D processing program offers the following functionality:

- ▶ **Changes the method of displaying data**
 - Display data in bird's eye view (3D), as an intensity distribution or using contour lines, as a spectral overlay, or rotated.
- ▶ **3D data processing**
 - Isolate changes at specific wavenumbers.
 - Functions include data extraction, data points thinning, smoothing, zero-baseline, background correction, normalization, log conversion, first- or second-order derivative, and ATR correction.
- ▶ **Creation of 3D data from spectra**
 - Create 3D data by consecutively arranging spectra measured at fixed intervals, such as by repeated measurements.

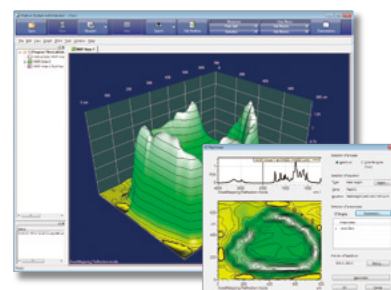

Note: The 3D processing program cannot control mapping measurements or AIM-8800 series infrared microscopes.

Contaminant Library for LabSolutions IR

(P/N 206-33179-91)

This unique library was created by Shimadzu especially for analyzing contaminants in tap water and food products. The library includes information about samples actually collected as contaminants and service parts commercially marketed for tap water applications. It also includes a collection of X-ray fluorescence profiles (PDF files). Consequently, it can significantly improve the precision of contaminant searches. Unlike the previous libraries, this is a mixture library that covers the extensive knowledge and experience necessary for qualitative analysis.

UV-Damaged Plastics Library*

(P/N 206-31808-41)

Unlike the previous libraries, this library includes information about plastics that have degraded due to oxidation associated with UV rays. It is especially useful for analyzing contaminants, which are commonly degraded. It is also effective in the analysis of unknown microplastics that are difficult to identify with standard libraries.

Thermal-Damaged Plastics Library*

(P/N 206-33039-91)

Unlike the previous libraries, this library includes information about plastics that have degraded due to oxidation associated with heat. It is especially useful for analyzing contaminants, which are commonly degraded.

* Shimadzu created this library from spectra measured and acquired from the Hamamatsu Industrial Technical Assistance Center of the Industrial Research Institute of Shizuoka Prefecture.

IRTracer, LabSolutions, eco mark, EDXIR-Analysis and EDXIR-Holder are trademarks of Shimadzu Corporation or its affiliated companies in Japan and/or other countries.
MIRacle is a trademark of PIKE Technologies.
Microsoft and Windows are either registered trademarks or trademarks of Microsoft Corporation in the United States and/or other countries.



Shimadzu Corporation
www.shimadzu.com/an/

For Research Use Only. Not for use in diagnostic procedures.

This publication may contain references to products that are not available in your country. Please contact us to check the availability of these products in your country.

Company names, products/service names and logos used in this publication are trademarks and trade names of Shimadzu Corporation, its subsidiaries or its affiliates, whether or not they are used with trademark symbol "TM" or "®".

Third-party trademarks and trade names may be used in this publication to refer to either the entities or their products/services, whether or not they are used with trademark symbol "TM" or "®".

Shimadzu disclaims any proprietary interest in trademarks and trade names other than its own.

The contents of this publication are provided to you "as is" without warranty of any kind, and are subject to change without notice. Shimadzu does not assume any responsibility or liability for any damage, whether direct or indirect, relating to the use of this publication.